

HITACHI
Inspire the Next



SRL SERIES

Oil Free Scroll Air Compressors

1.5–33 kW



 Hitachi Global Air Power Australia Pty Ltd



Sullair and Hitachi

When Sullair became A Hitachi Group Company in July, 2017 — two compressor titans joined forces — bringing customers more solutions to achieve their compressed air needs.

Since 1965, Sullair has been recognized worldwide as an innovator and leader in rotary screw compression and vacuum technology. Now — with the combination of more than 100 years of Hitachi compressor engineering experience and the dedicated sales, service and distribution experience of Sullair — presenting the SRL Series of Oil Free Scroll Compressors. The SRL Series represents the best of more than 35 years of Hitachi oil free scroll compressor experience and expertise.

**RELIABILITY.
DURABILITY.
PERFORMANCE.**

These are the pillars that drive the quality of Sullair compressed air solutions. It's a promise we keep with every machine we make.

RELIABILITY

Customers who work with Sullair have found that the intangibles make all the difference — things like trust, confidence, and peace of mind. They go to work every day having full faith in their equipment, as well as the knowledge that dedicated distributors and Sullair personnel have their back every step of the way.

DURABILITY

Bulletproof. Built to last. However you spin it, Sullair compressed air solutions are in it for the long haul. In factories and shops all over the world, you'll find Sullair compressors that have stood the test of time, running consistently today like they did on day one.

PERFORMANCE

You have high expectations for your operations, and we make machines that share your work ethic. Sullair compressed air solutions do what they're supposed to do, and they do it extremely well for a very long time. And working with us means not only access to clean, quality air, but also the tools you need to optimize this vital resource.



OIL FREE

THE SULLAIR OIL FREE SEAL

The Sullair Oil Free Seal is your assurance the compressor produces the clean air required for your operational needs. All Sullair compressors which meet the ISO standard for Class 0 oil free air ISO 8573-1 carry the Sullair Oil Free Seal.

OIL FREE COMPRESSION WITH SCROLL TECHNOLOGY

SRL Series scroll air compressors are the perfect choice for applications requiring oil free air, including:

- Pharmaceuticals
- Food and beverage manufacturing
- Electronics
- High-technology manufacturing
- Research & Development applications
- Robotics
- Dental applications
- Automotive
- Paint
- High quality oil free instrument air

Why Oil Free?

In many operations, compressed air comes into contact with items in the manufacturing process. When air purity is critical — oil free air is essential. Oil particulates in compressed air can contaminate downstream processes and production. Oil Free compressors help eliminate potential contamination as no oil or lubricant is introduced into the air compression process. Reduced risk of contamination helps improve your business operations and profitability.

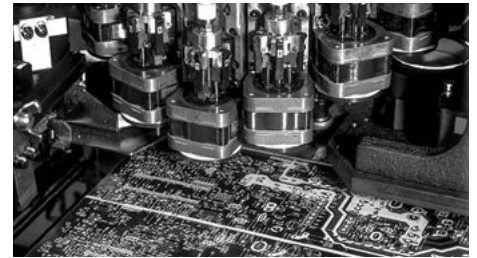

AIR QUALITY STANDARDS

ISO 8573-1 CLASSES

Class	Solid Particle Maximum number of particles per m ³			Pressure Dew Point °F (°C)	Oil (incl. vapor) mg/m ³
	0.1–0.5 micron	0.5–1.0 micron	1.0–5.0 micron		
0	As specified by the end-user or manufacturer, and more stringent than Class 1				
1	≤ 20,000	≤ 400	≤ 10	≤ -94° (-70°)	0.01
2	≤ 400,000	≤ 6,000	≤ 100	≤ -40° (-40°)	0.10
3	—	≤ 90,000	≤ 1,000	≤ -4° (-20°)	1.00
4	—	—	≤ 10,000	≤ 37.4° (3°)	5.00
5	—	—	≤ 100,000	≤ 44.6° (7°)	—
6	—	—	—	≤ 50° (10°)	—

Class 0 Oil Free Air — For applications in which air purity is essential, including pharmaceuticals, food and beverages, electronics, automotive painting, and textiles.

SRL Series compressors are certified oil free under ISO8573-1.



Common Air Contaminants

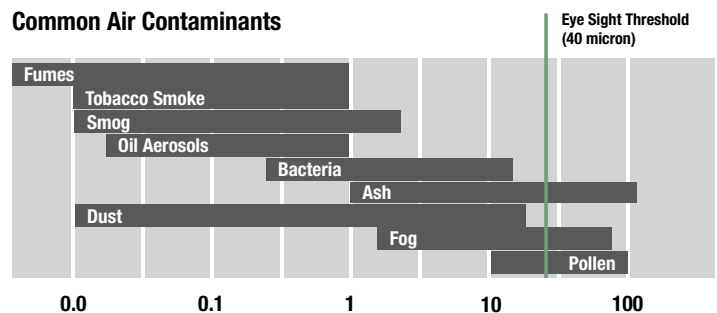

SRL SERIES



OIL FREE SCROLL PRODUCT OVERVIEW									
Motor Output — Horsepower (hp)	2	3	5	7.5	10	15	22.5	30	44
Motor Output — Kilowatts (kW)	1.5	2.2	3.7	5.5	7.5	11	16.5	22	33
Simplex (single air pump)	■		■		■		■		■
Multiplex (up to six air pumps)	■		■		■		■		■
Rated Pressure (bar)	8.5	8.5-10	8.5	8.5-10	8.5-10	8.5-10	8.5-10	8.5-10	8.5-10

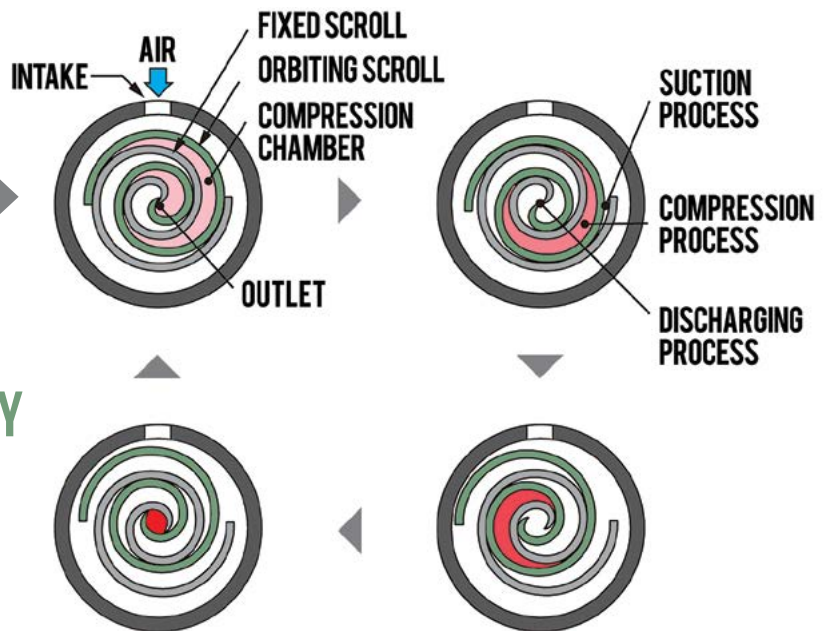

SCROLL COMPRESSION TECHNOLOGY

Within each SRL Series pump are two scrolls —one orbiting; one fixed. Air entering the compression chamber is gradually reduced as the orbiting scroll rotates. Compressed air is exhausted through the outlet at the center. Because air movement is continuous from the suction port through the discharge port, scroll compressors provide pulsation free delivery of compressed air.

THE SRL SERIES DIFFERENCE

The SRL Series provides oil free air reliably, efficiently and quietly!

Built on Hitachi engineering, the SRL Series represents advanced scroll compressor technology to meet your oil free compressed air needs — today and tomorrow.

SRL EXCLUSIVE SCROLL AND PUMP DESIGN

- Patented scroll wrap design with labyrinth seal provides superior performance and reliability
- Proprietary tip seal reduces air leakage while extending service intervals
- Two air inlets to reduce stress on pump (5.5 kW pump only)
 - Leads to tighter upper air band
 - Extends life of pump
- Normal maintenance can be completed without disassembling pump



INTEGRATED DESIGN FOR MAXIMUM USER BENEFITS

- Highly efficient cooling
 - Multi stage cooling reduces ambient temperature out
- Receiver tank helps dissipate heat while reducing compressor starts/stops
- Air pressures to 10 bar
- Extremely quiet
 - Full enclosure standard
 - Mechanical and electrical vibration isolation
 - Designed to be placed at point of air need
 - Sound levels as low as 45dB(A)
- Compact design reduces floor space needed
- Maintenance friendly
 - Easy accessibility for inspection and maintenance



EFFICIENT COMPRESSOR OPERATIONS = ENERGY SAVINGS

Maximizing efficiency means more than just having an efficient air compressor. All SRL Series compressors feature built-in logic to help utilize the air compressors most efficiently — which not only saves wear and tear on the compressor, but also provides energy savings — which saves you money!

Multi-Drive Control (Multiplex Units Only)

Patented multi-drive control monitors compressor operation, predicts compressed air needs, then modifies operation automatically by:

- Shutting down compressor pumps not needed
- Lowering maximum pressure setting automatically

This process saves energy by not producing unneeded air. Shifting the operating load among the available compressor pumps helps extend the life of the compressor, and Multi-Drive Control maintains necessary pressure to prevent pressure drop.

Pressure Switch Mode

When the compressor operates in Pressure Switch Mode, the compressor pump (pumps in Multiplex units) stops automatically when the maximum pressure is reached. When the system reaches recovery pressure, each pump in the compressor restarts.

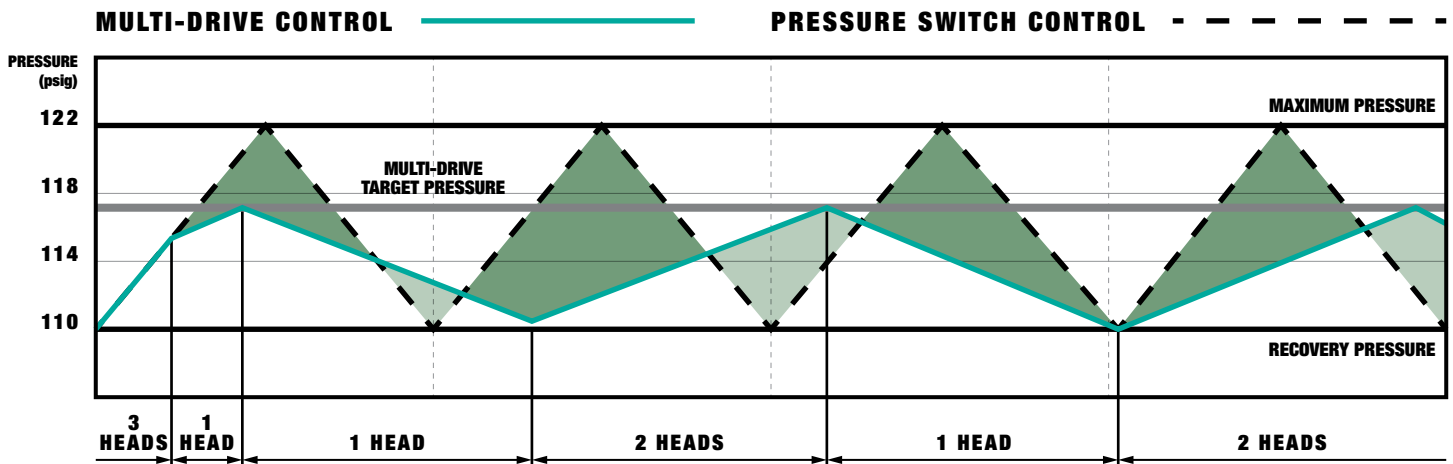

Cycle Control Logic

Lowering maximum pressure is frequently done to save energy. However, too low a pressure can result in excessive on/off cycling, increasing wear and tear on the compressor. Cycle Control Logic automatically adjusts the maximum pressure rating to elongate on/off cycles — reducing excessive restarting.

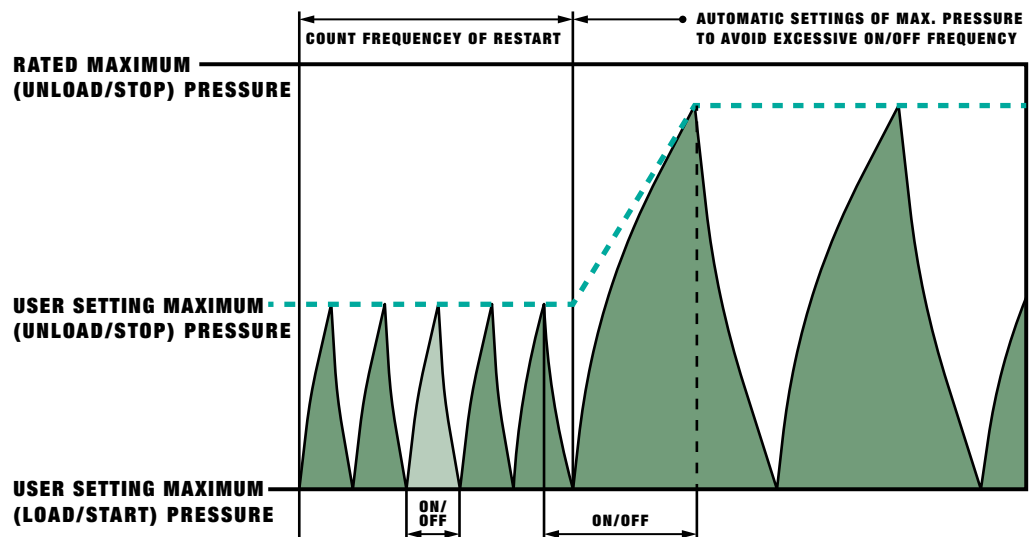



SRL SERIES (SIMPLEX SHOWN)

1. Control Panel
2. Emergency Stop button
3. Starter Panel
4. Condensate Drain Valve

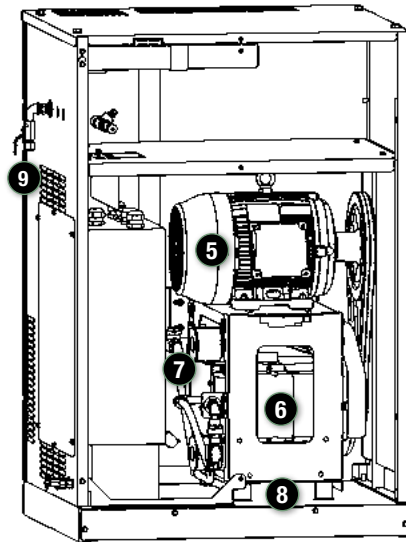

5. Electric Main Motor

- 1.5, 2.2, 3.7 or 5.5 kW
- 1500 rpm
- Simplex package – 1 motor
- Multiplex package – 1 motor per scroll pump
- TEFC standard

6. SRL Scroll Pump

- Simplex – 1 scroll pump
- Multiplex – up to 6 scroll pumps
- No disassembly needed for normal maintenance

7. Intake Air Filter

8. Rubber Vibration Isolators — help reduce vibration and operating noise

9. Discharge Stop Valve

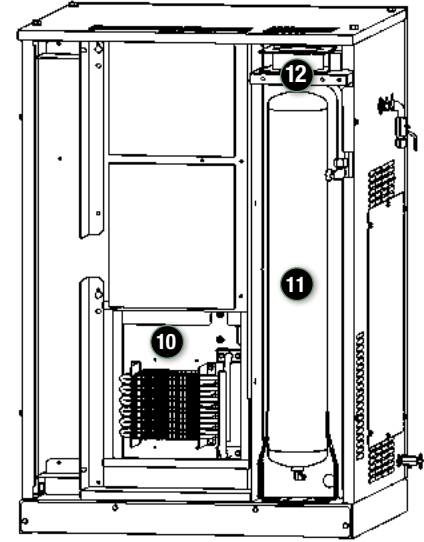

Multi-Stage Cooling Reduces Need for High Temp Dryers

10. Primary Aftercooler

11. Air Receiver Tank

- Helps dissipate heat
- Reduces starts and stops, which helps reduce stress on scroll pump

12. Ventilating Fan — provides secondary aftercooling

SRL SERIES — CONTROLLER

1. Digital Display — shows discharge pressure; total run hours; alarm/errors (if applicable)
2. Indicator Lights — top = Discharge Pressure (psig); bottom = Operating Time (x10 Hours)
3. Screen Shift Switch — toggles display
4. Compressor Operation Light — shows green while compressor is in operation
5. Control Mode Switch (Multiplex Models Only) — changes compressor control modes
6. Maintenance Alert — Light shows when maintenance intervals have been reached
7. Compressor Start/Stop Switches

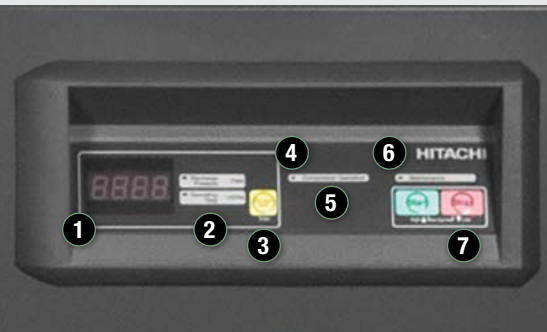

TECHNICAL SPECIFICATIONS

FOR MORE INFORMATION,
CONTACT YOUR LOCAL SULLAIR OFFICE.

SRL SERIES – 50 Hz										
MODEL	MAX PRESSURE (Bar)	CAPACITY – FREE AIR DELIVERY			MOTOR RATING		NOISE LEVEL (dBA)	APPROX WEIGHT (Kg)	NO. OF SCROLLS	DIMENSIONS IN mm (D x W x H)
		L/S	m ³ /min	CFM	kW	HP				
SRL 1.5	8.5	2.6	0.16	5.6	1.5	2	45	119	1	680 x 640 x 1030
SRL 2.2	8.5	4	0.24	8.5	2.2	3	46	129	1	680 x 640 x 1030
SRL 2.2 – 10	10	3.3	0.20	7.1	2.2	3	46	129	1	680 x 640 x 1030
SRL 3.7	8.5	6.7	0.40	14.1	3.7	5	47	175	1	750 x 715 x 1070
SRL 5.5	8.5	10	0.60	21.2	5.5	7.5	50	184	1	750 x 715 x 1070
SRL 5.5 – 10	10	8.3	0.50	17.7	5.5	7.5	50	184	1	750 x 715 x 1070
SRL 7.5	8	14.7	0.88	31.1	7.7	10.3	57	315	2	980 x 660 x 1190
SRL 7.5 – 10	10	11.7	0.70	24.7	7.7	10.3	57	312	2	980 x 660 x 1190
SRL 11	8	21	1.26	44.5	11	14.7	59	350	2	980 x 660 x 1190
SRL 11 – 10	10	16.7	1.0	35.3	11	14.7	59	344	2	980 x 660 x 1190
SRL 16.5	8	31.5	1.89	66.7	16.5	22.1	61	515	3	1280 x 770 x 1450
SRL 16.5 – 10	10	25	1.50	53.0	16.5	22.1	61	506	3	1280 x 770 x 1450
SRL 22	8	42	2.52	89.0	22	29.5	61	720	4	1330 x 880 x 1900
SRL 22 – 10	10	33.3	2.0	70.6	22	29.5	61	708	4	1330 x 880 x 1900
SRL 33	8	63	3.78	133.4	33	44.2	63	1000	6	1360 x 1030 x 1670
SRL 33 – 10	10	50	3.0	105.9	33	44.2	63	1000	6	1360 x 1030 x 1670

QUIET OPERATION

SRL Series compressors are not just quiet — they are super quiet. Noise levels as low as 48 dBA make Sullair SRL Series compressors suitable for indoor applications and do not require a separate sound attenuated room. In fact, these compressors may be installed at point-of-use which results in lower installation and piping costs.

Comparative Noise Levels

dBA

40	Library	85	Noisy restaurant
As low as 45dB(A)	SRL Series	90	Tractor
50	Rainfall	100	Factory machinery
55	Coffee percolator	110	Leaf blower
60	Sewing machine	120	Thunder
70	Freeway traffic	130	Jackhammer
80	Doorbell		

Source: Center for Hearing and Communication

